

STAGE 1

Course: Long Course/Comstock
Targets: 10 IPSC targets, some penalty targets
Distance: 5 - 20m
Poss. Points: 100
Min. Rounds: 20
Start/Stop: audible signal/last shot
Start Position: Gun ready in the holster, standing relaxed in box A
Procedure: At the signal engage targets T1 to T10 free style from within the designated area

STAGE 2

Course: Long Course/Comstock
Targets: 10 IPSC targets, some penalty targets
Distance: 5 - 20m
Poss. Points: 100
Min. Rounds: 20
Start/Stop: audible signal/last shot
Start Position: Gun ready in the holster, standing relaxed in box A.
Procedure: At the signal engage targets T1 to T10 free style only from within the designated area

STAGE 3

Course: Short Course/Comstock
Targets: 2 IPSC targets, 5 pepper poppers
Distance: +-12m
Poss. Points: 45
Min. Rounds: 9
Start/Stop: audible signal/last shot
Start Position: Gun unloaded at the floor and standing in box a.
Procedure: At the signal load the gun and engage all targets.

STAGE 4

Course: Long Course/Comstock
Targets: 15 IPSC targets, some penalty targets, 2 pepper poppers
Distance: 5 – 20m
Poss. Points: 160
Min. Rounds: 32
Start/Stop: audible signal/last shot
Start Position: Gun ready in the holster, standing relaxed in box A.
Procedure: At the signal engage targets T1 to T15 free style only from within the designated area
Note: T15 will be visible after engaging PP2.

STAGE 5

Course: Long Course/Comstock

Targets: 11 IPSC targets, some penalty targets, 5 pepper poppers, 3 mini pepper poppers

Distance: 5 - 20m

Poss. Points: 150

Min. Rounds: 30

Start/Stop: audible signal/last shot

Start Position: Gun ready in the holster standing relaxed in box a.

Procedure: At the signal engage targets T1 to T11 free style only from within the designated area

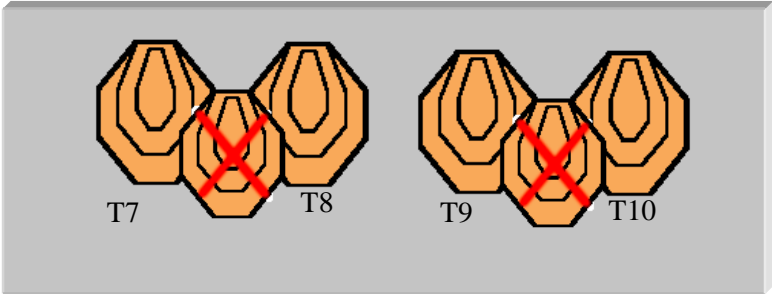

STAGE 1

T4

T3

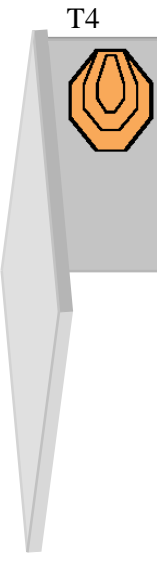
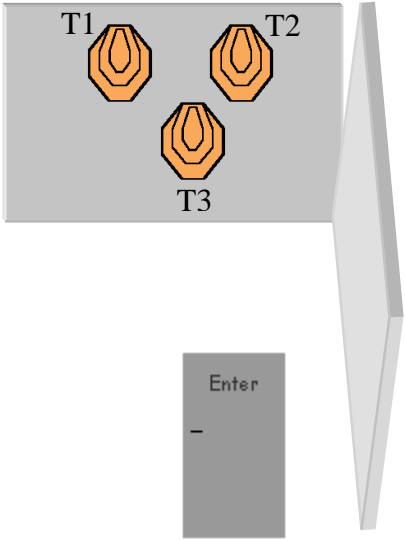
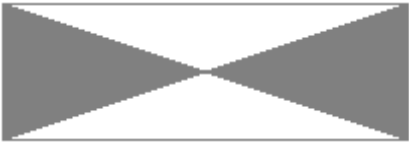

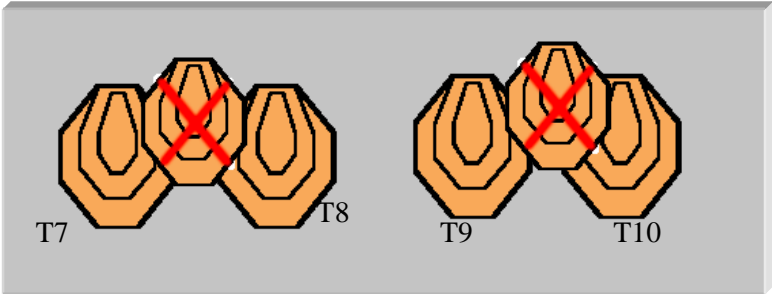

STAGE 2



T3
T4

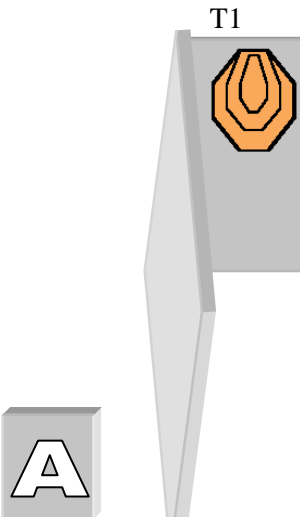
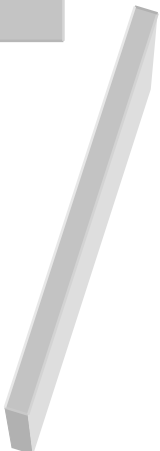
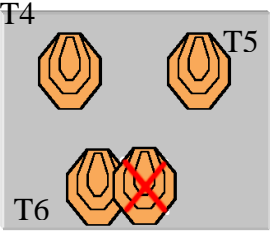

PP1 PP2 PP3 PP4 PP5



T7

STAGE 3

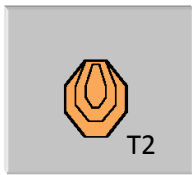

T1 T2

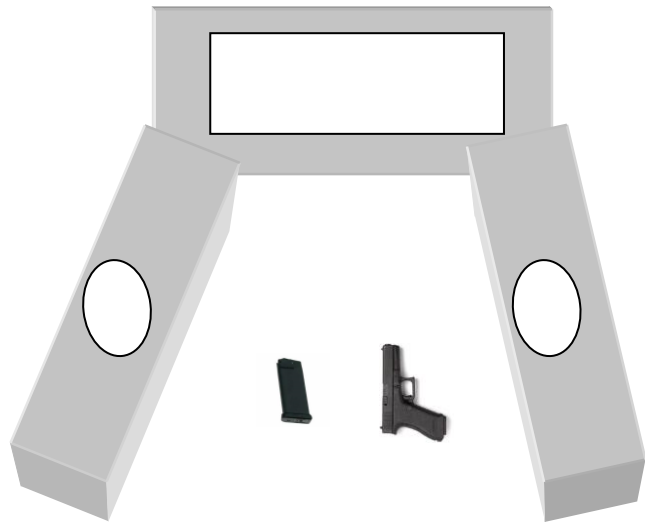

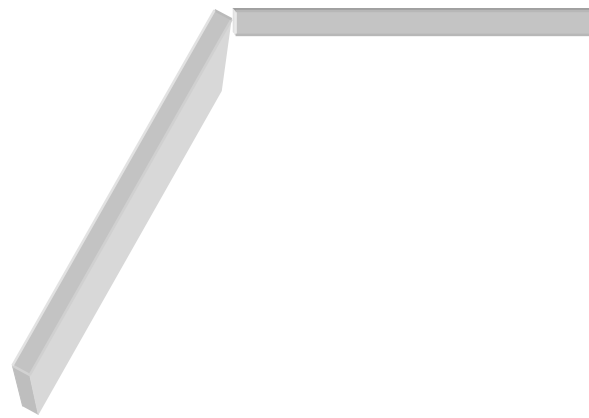
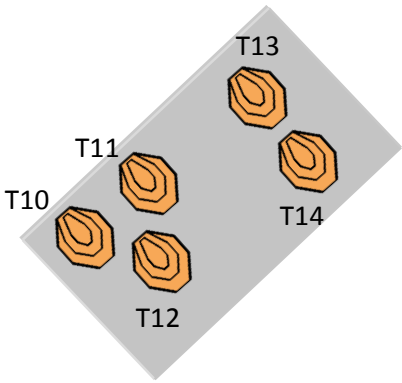
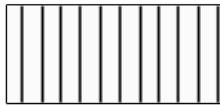
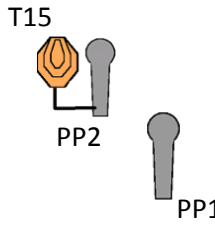

STAGE 4

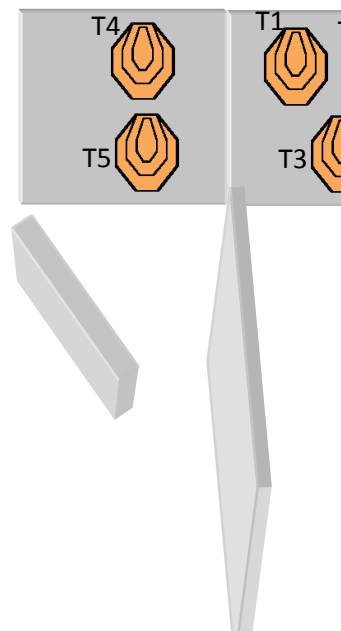
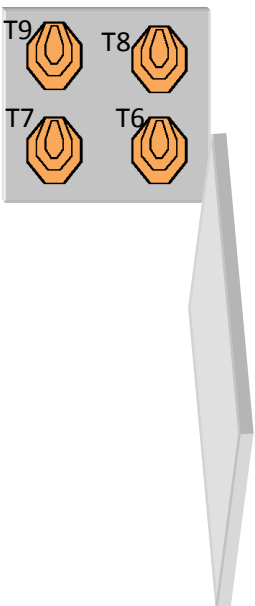

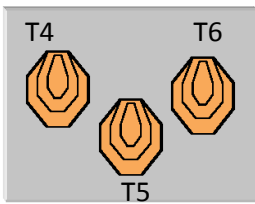
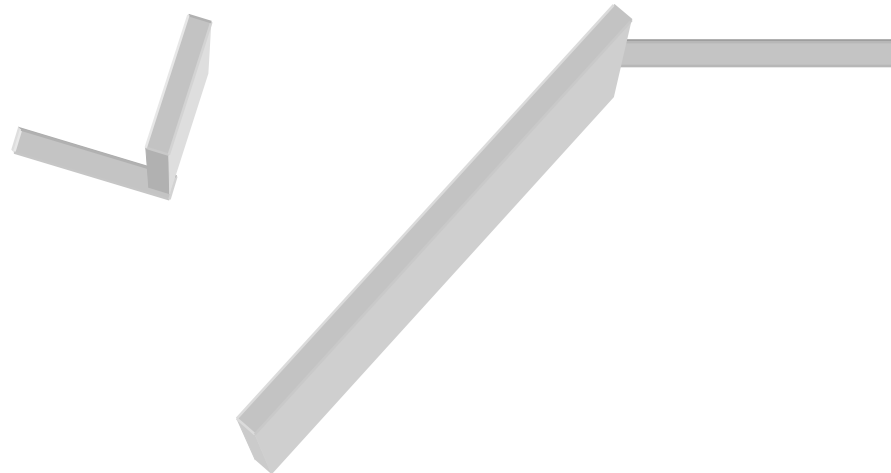
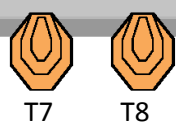
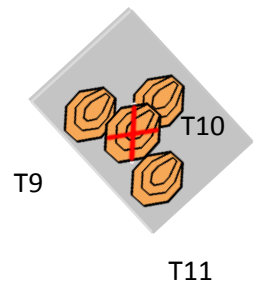
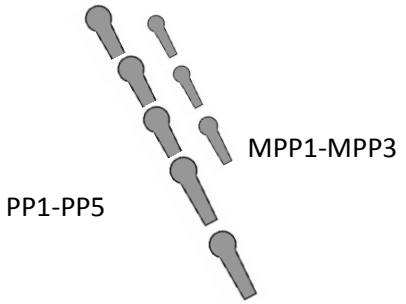

STAGE 5

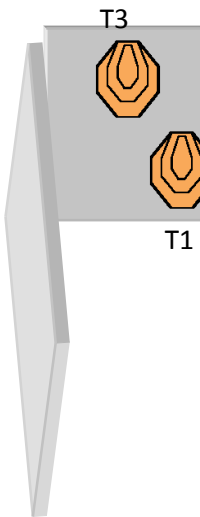

A

